

B-1a	1651	400	16	x 1	1/1
B-1b	1651	400	16	x 1	1/1
B-2	340	380	16	x 1	1/1
B-3	340	380	16	x 1	1/1
B-4	340	365	16	x 1	1/1
B-5	340	365	16	x 1	1/1
B-6	526	365	16	x 2	1/1
B-7a	547	200	16	x 1	1/1
B-7b	547	200	16	x 1	1/1
B-8a	350	120	16	x 1	1/1
B-8b	350	120	16	x 1	1/1
B-9	470	120	16	x 2	1/1
B-10	334	378	16	x 1	1/1
B-11	340	186	16	x 1	1/1
B-12	340	24	18	x 4	1/1
B-13	470	120	3	x 1	1/1
B-14	1632	684	3	x 1	1/1

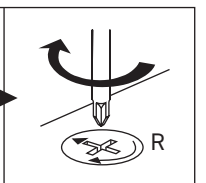

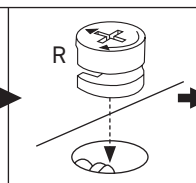

1

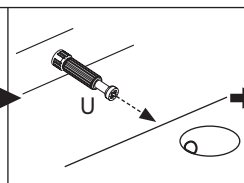
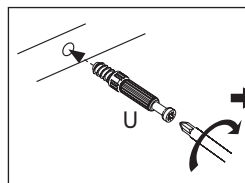
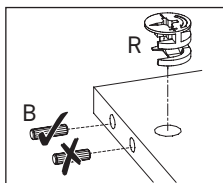
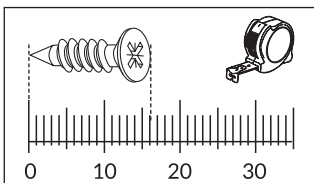
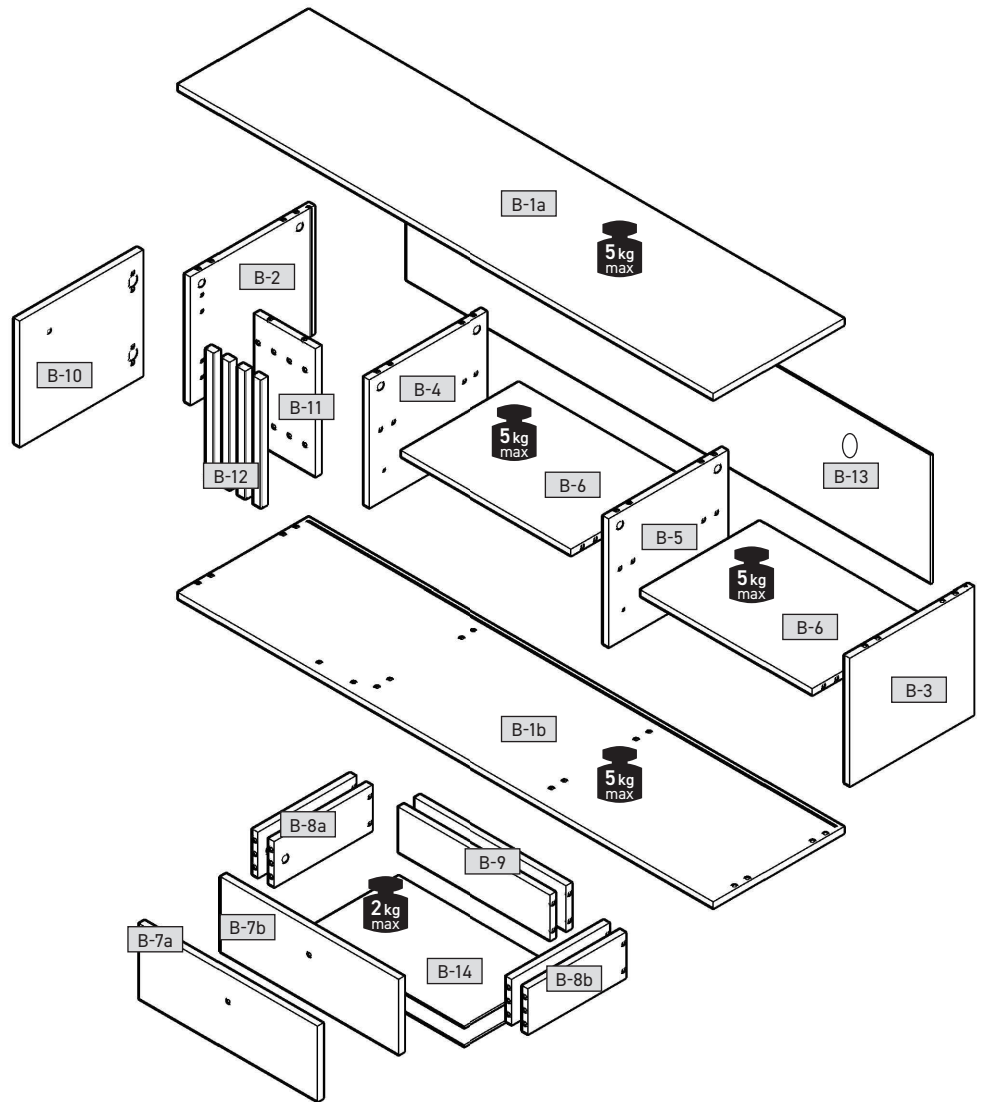
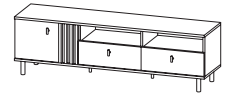
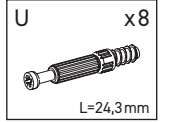
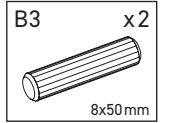
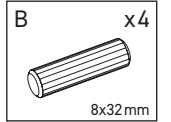
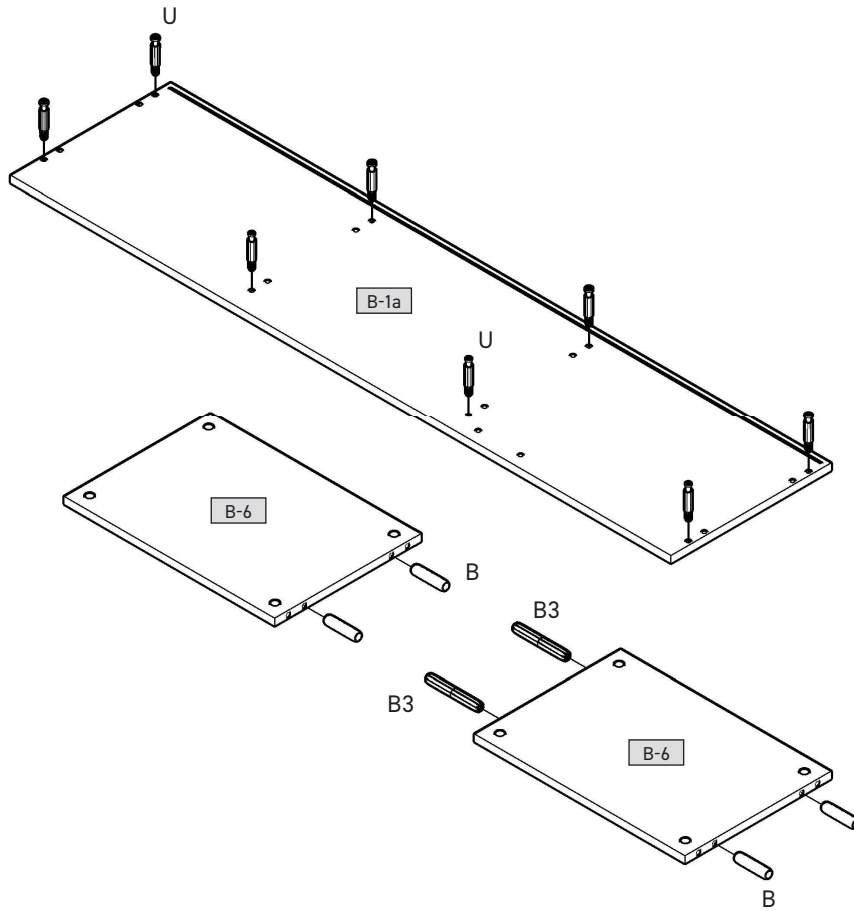
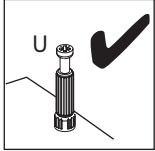
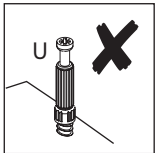

2

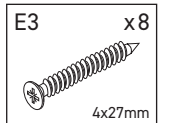
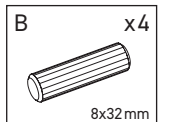
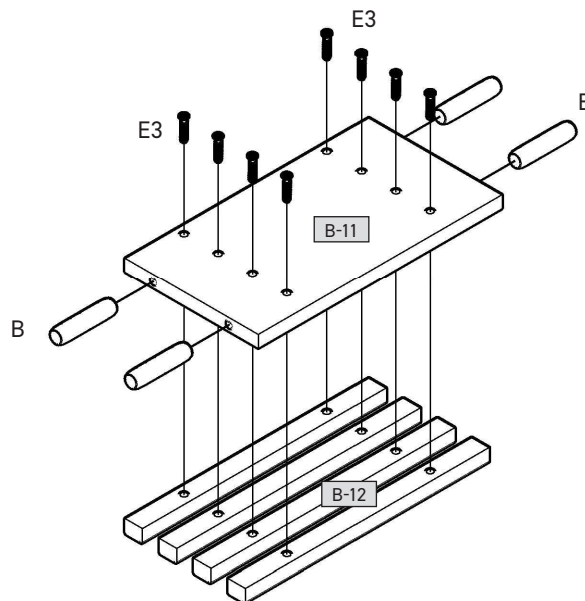
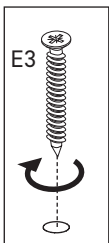

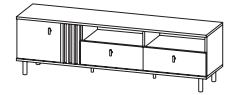

3

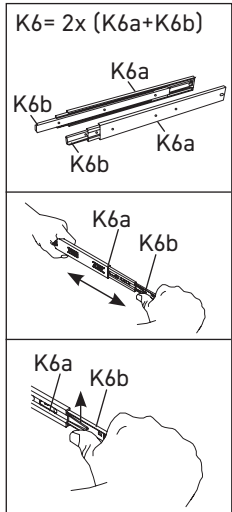
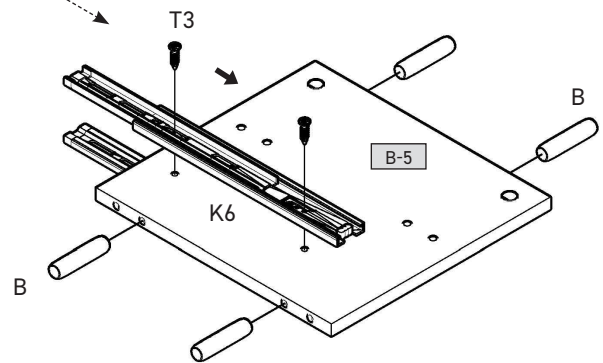
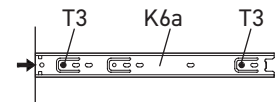
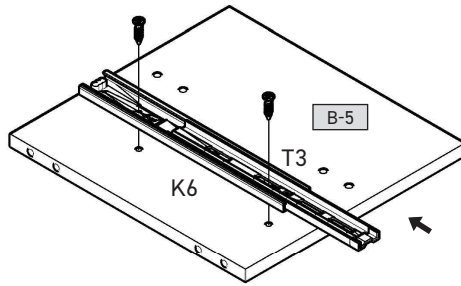
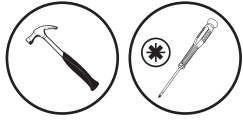
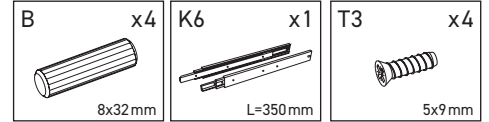
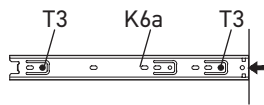

4

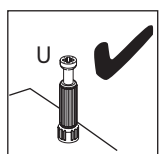
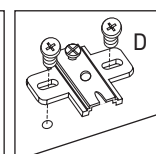
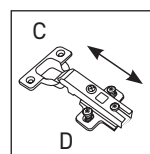
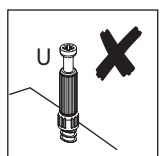
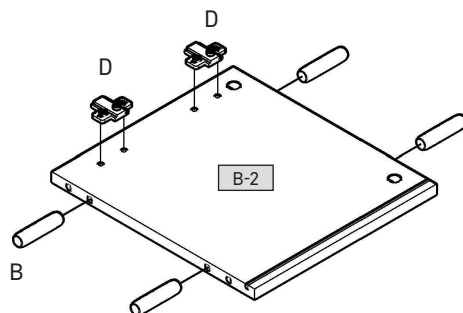
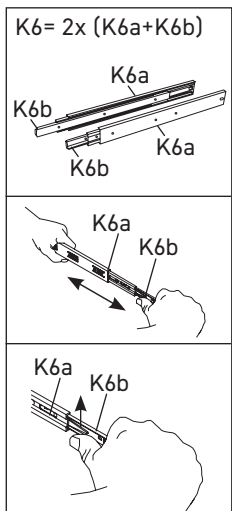
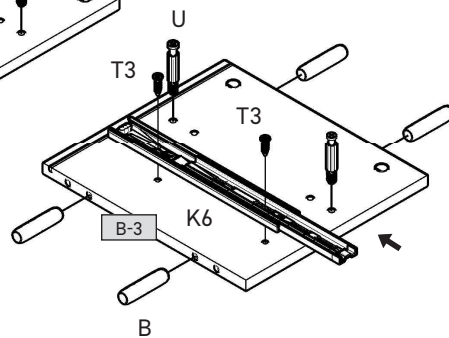
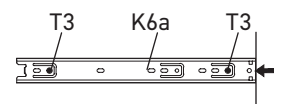
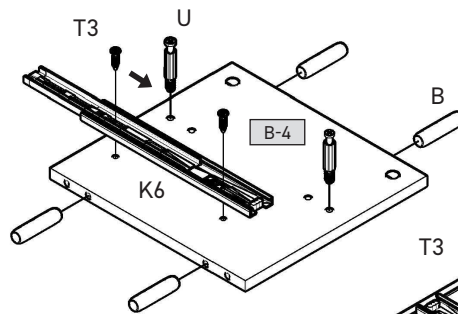
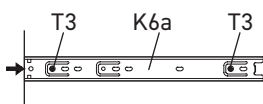
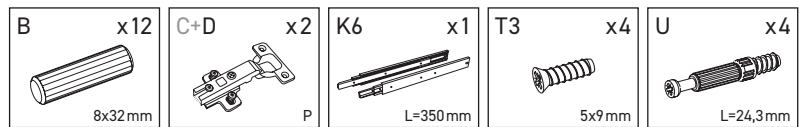

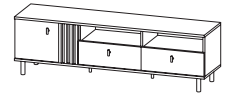

5

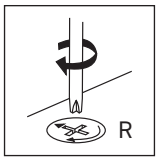
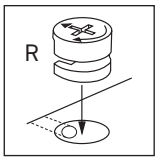
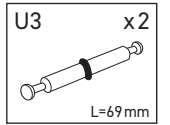
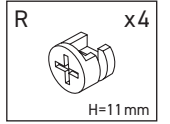
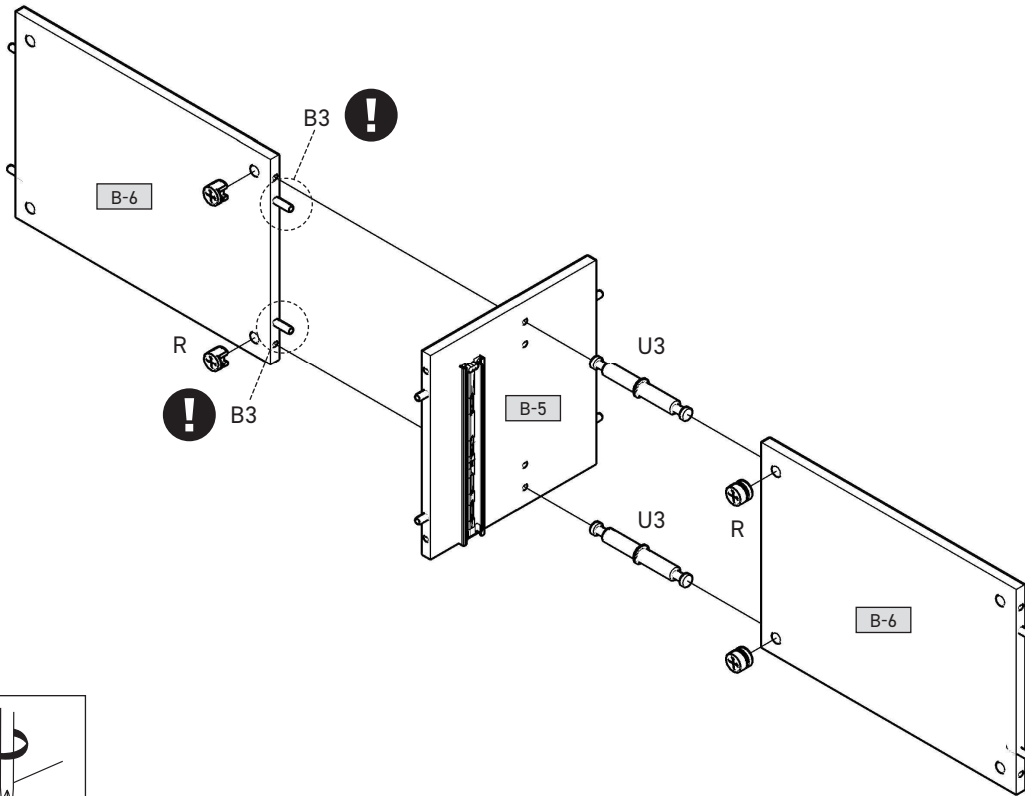

6

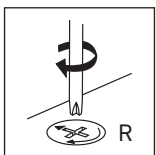
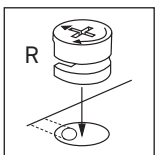
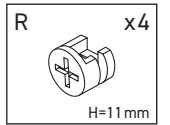
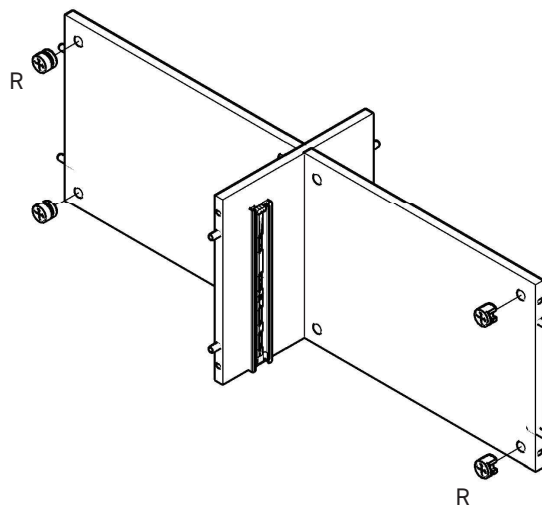
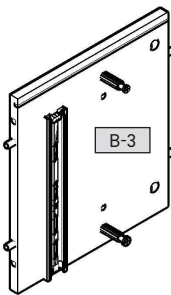

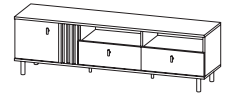

7

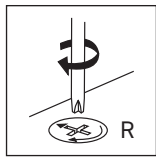
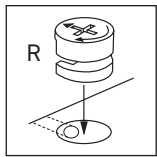
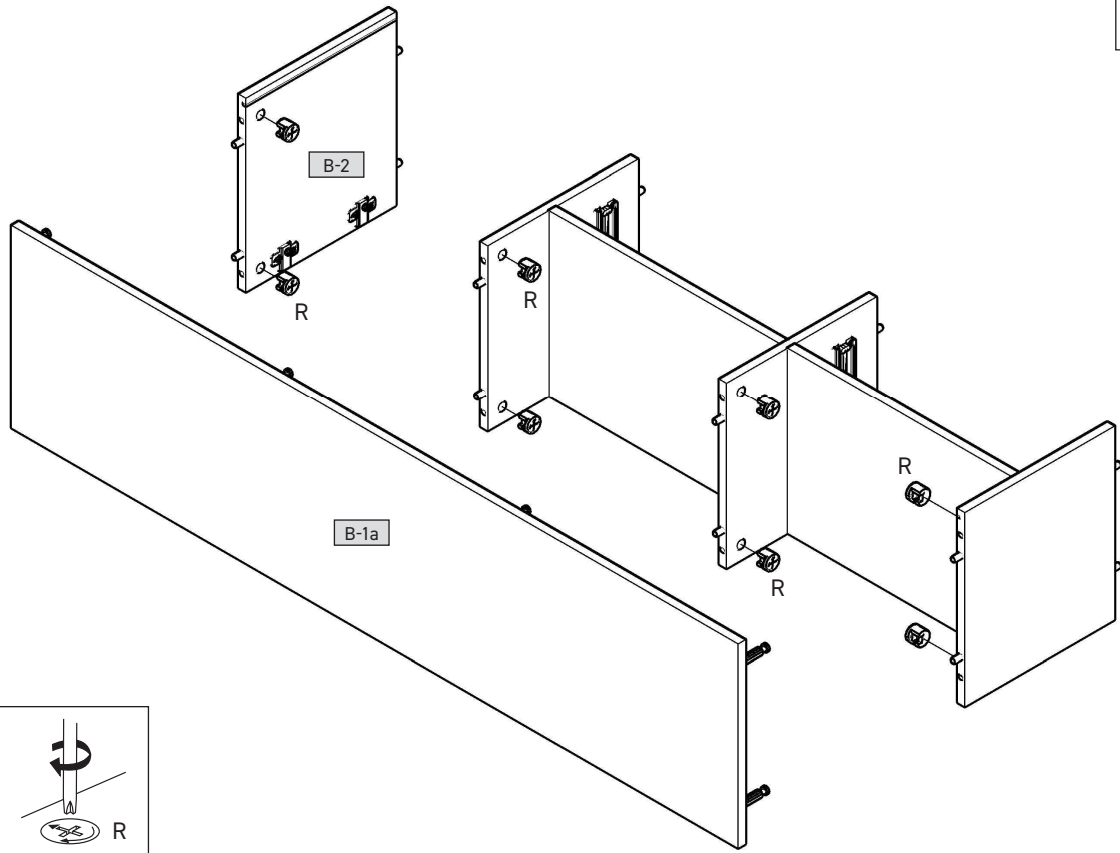
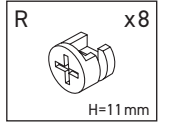

8

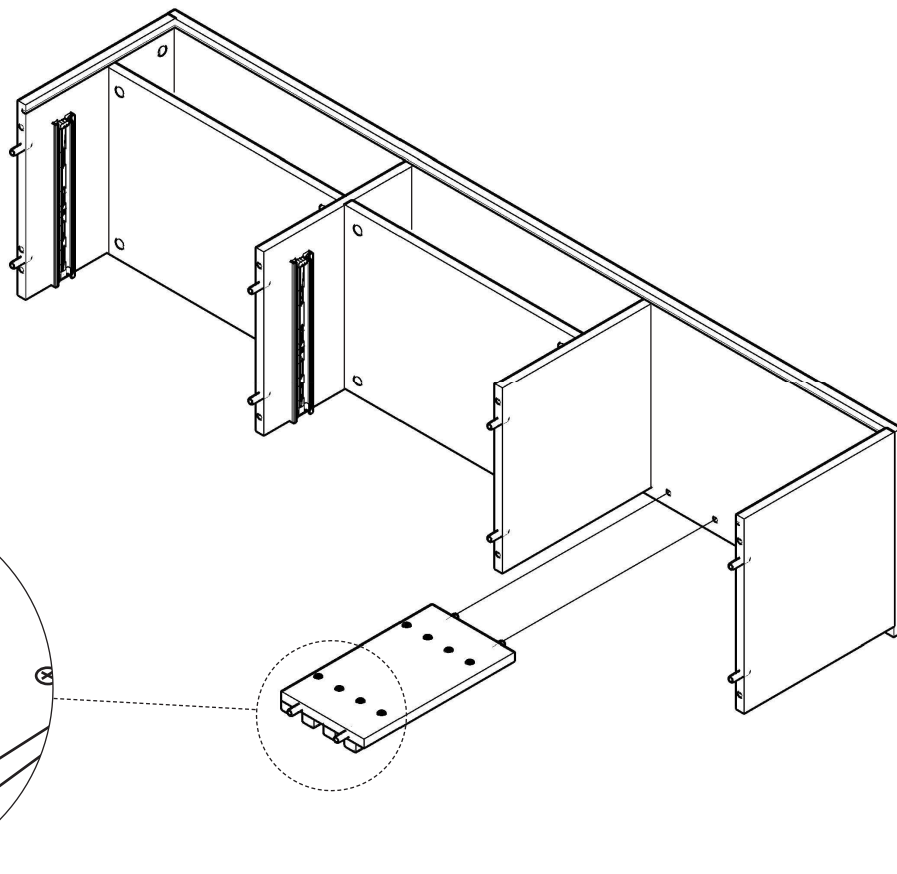

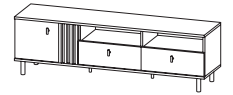

9

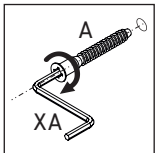
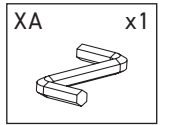
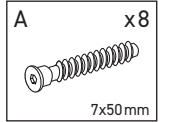
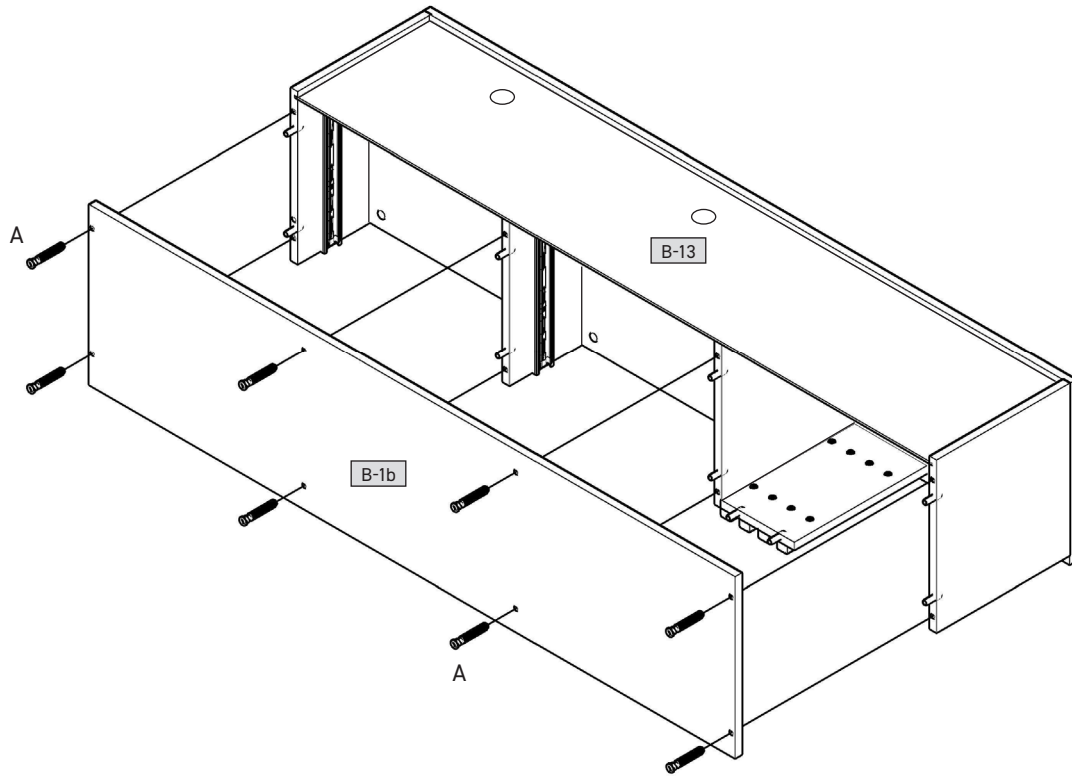

10

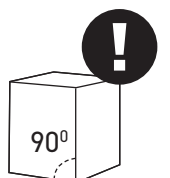
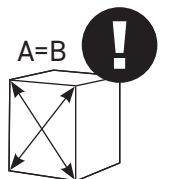
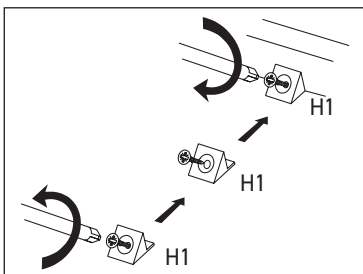
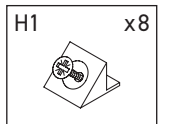
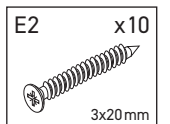
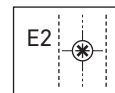
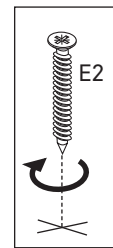
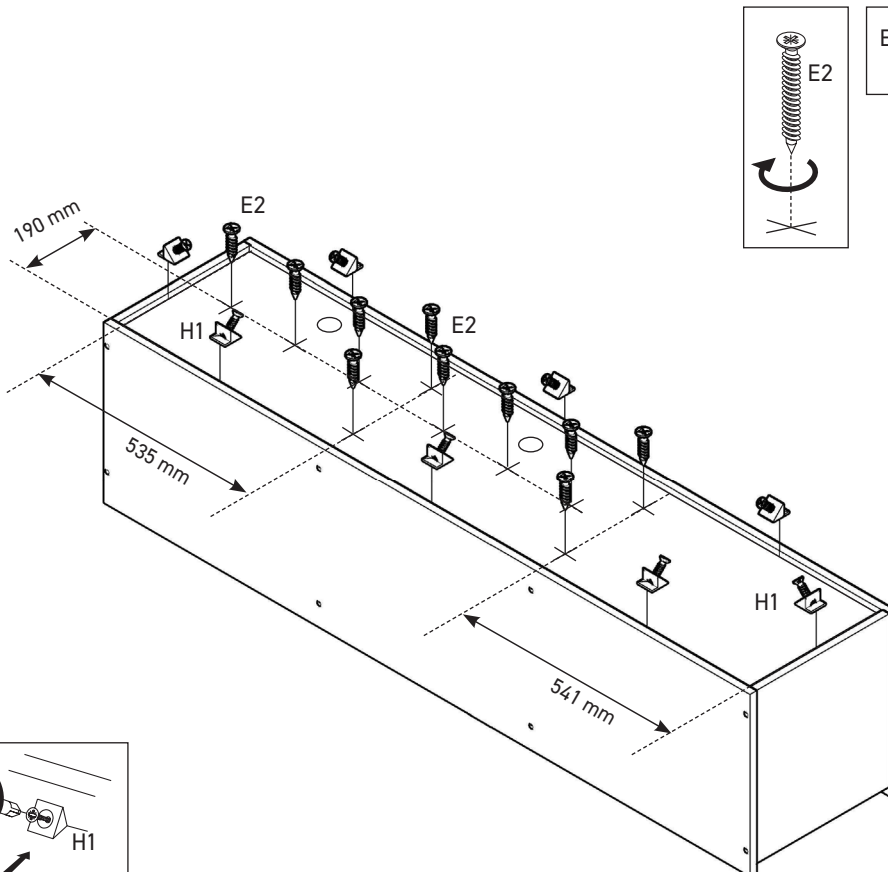

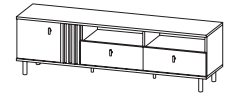

11

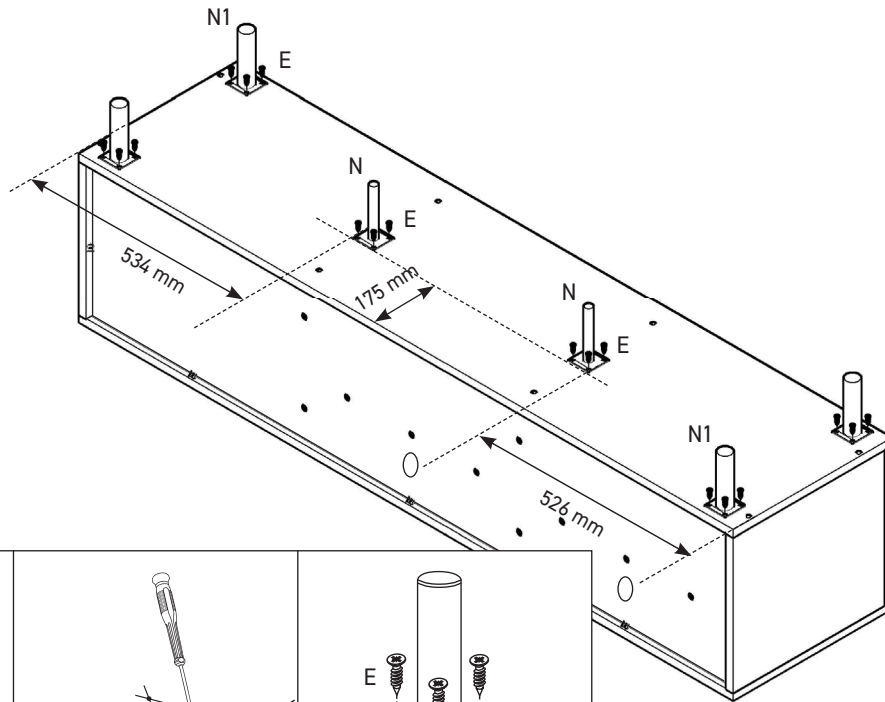
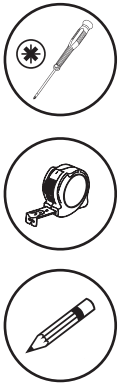

- E** x24  
3,5x13mm
- N** x2  
Ø18 / H=120mm
- N1** x4  
Ø30 / H=120mm

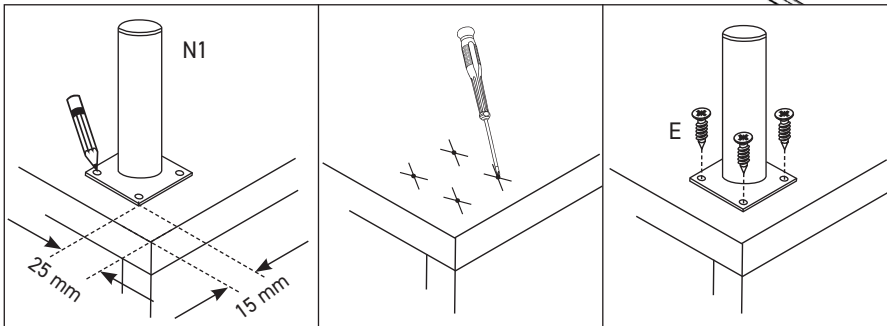

12

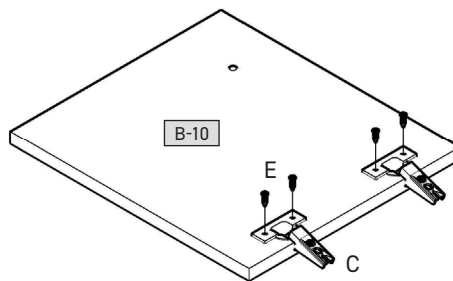
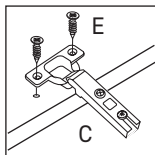

- C+D** x2  
P
- E** x4  
3,5x13mm

13

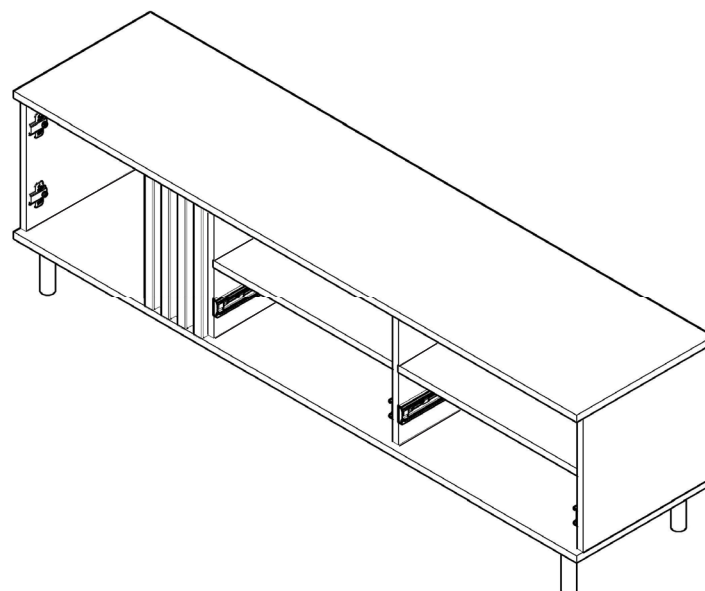
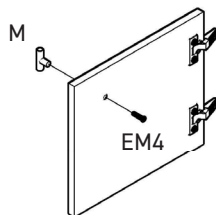

- EM4** x1  
4x40mm
- M** x1  
GS10

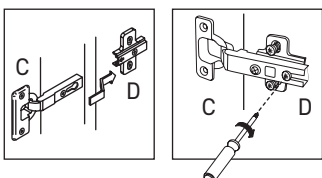



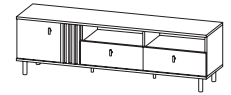

14

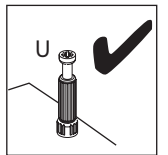
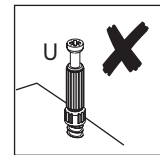
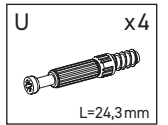
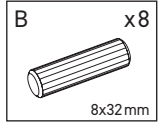
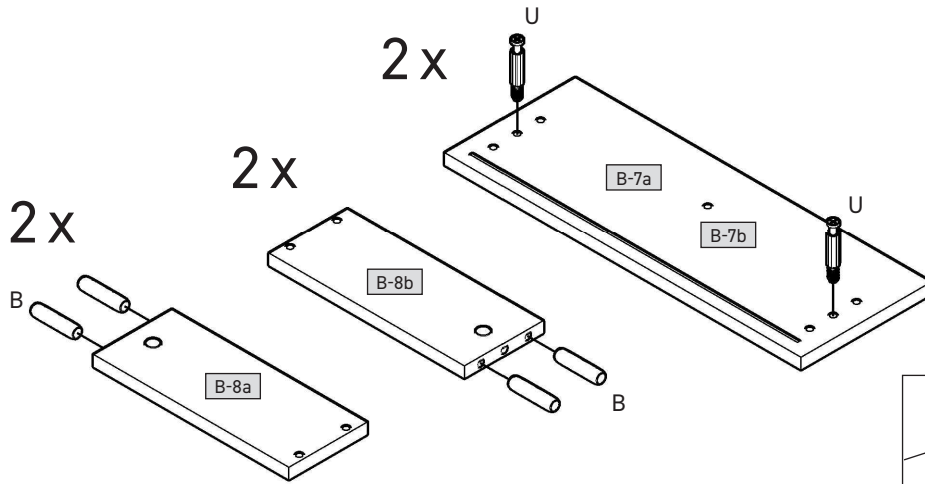

15

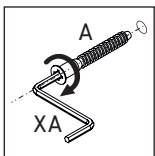
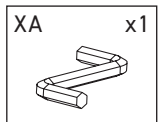
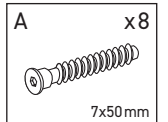
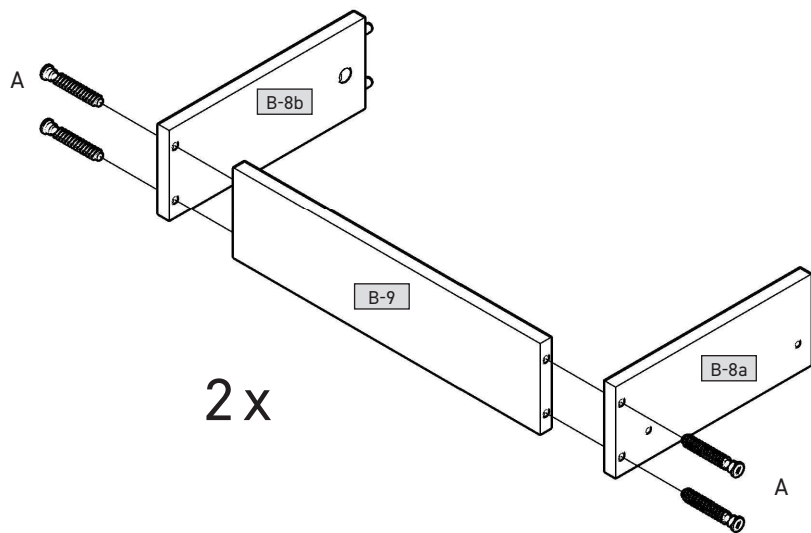

16

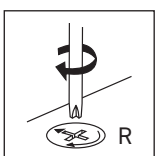
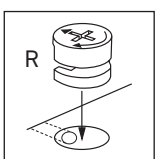
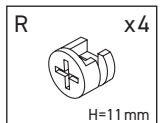
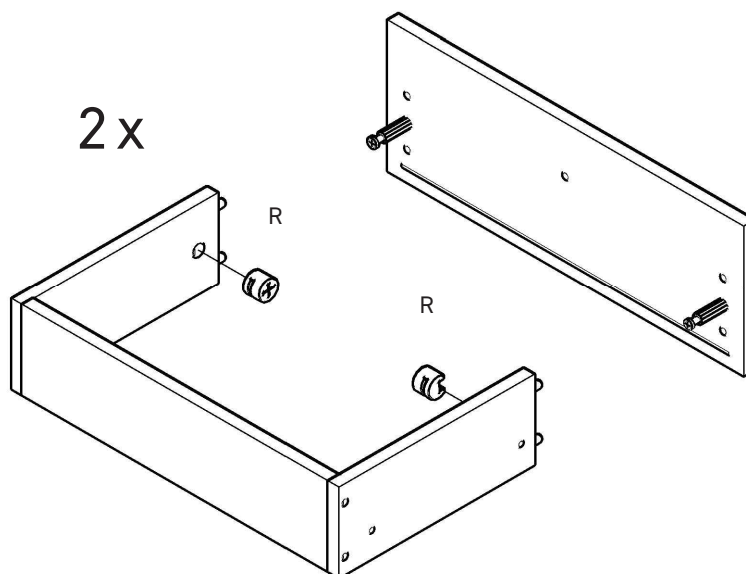

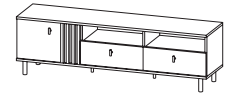

17

2 x

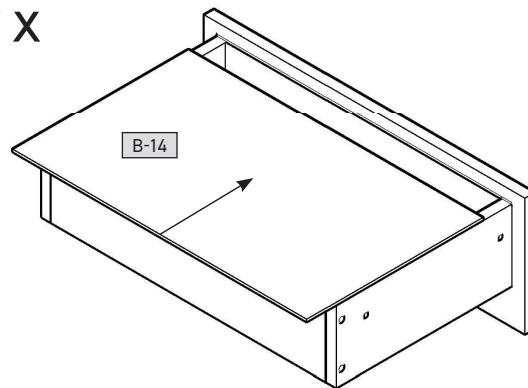

18

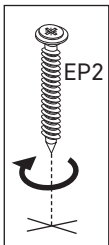

2 x

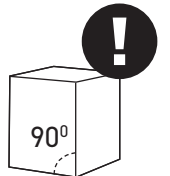
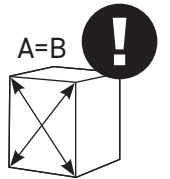
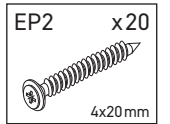
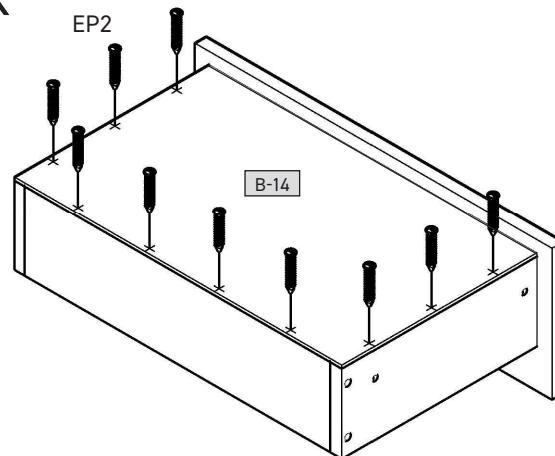

19



2 x

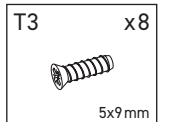
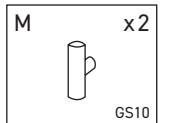
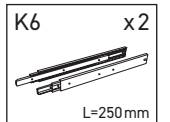
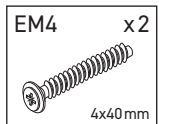
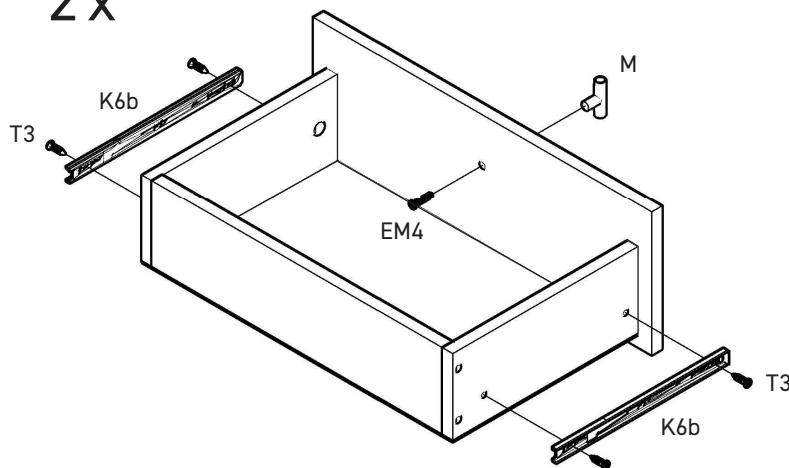

K6 = 2x (K6a + K6b)

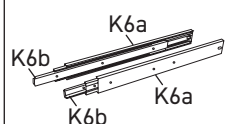



20

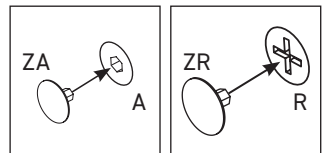
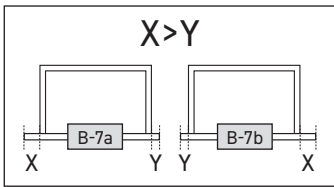
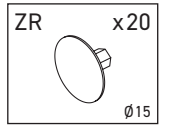
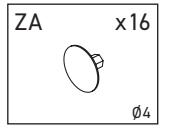
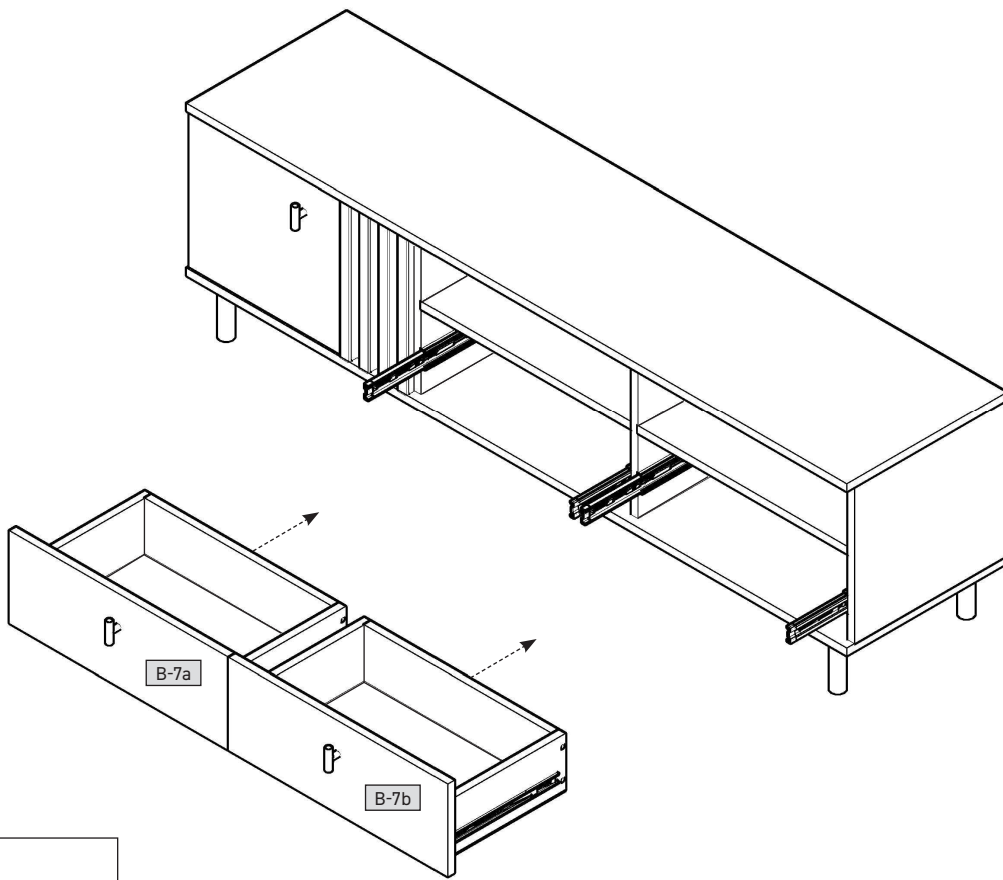
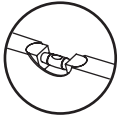

21

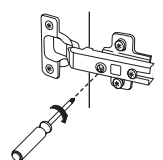
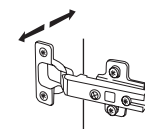
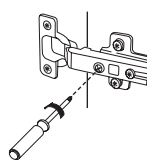
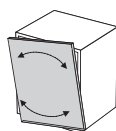
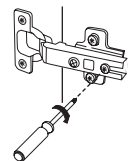
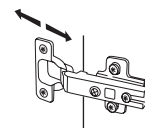
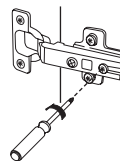
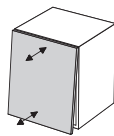
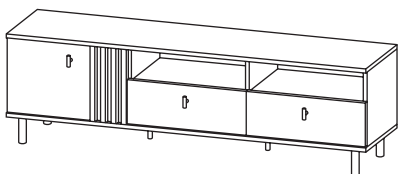
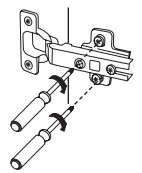
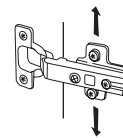
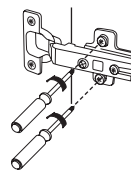
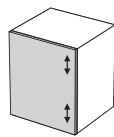

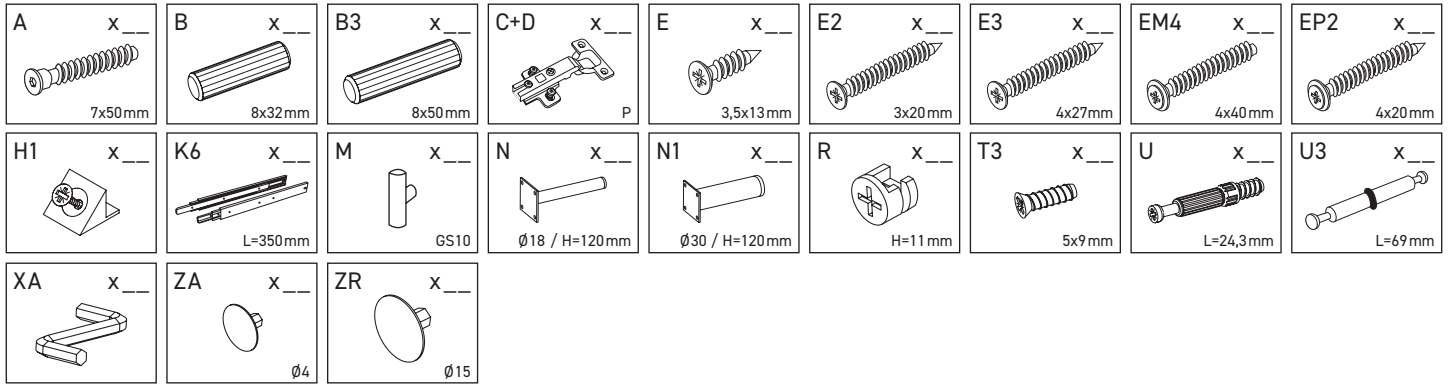

B-1a	1651	400	16	x 1	1/1
B-1b	1651	400	16	x 1	1/1
B-2	340	380	16	x 1	1/1
B-3	340	380	16	x 1	1/1
B-4	340	365	16	x 1	1/1
B-5	340	365	16	x 1	1/1
B-6	526	365	16	x 2	1/1
B-7a	547	200	16	x 1	1/1
B-7b	547	200	16	x 1	1/1
B-8a	350	120	16	x 1	1/1
B-8b	350	120	16	x 1	1/1
B-9	470	120	16	x 2	1/1
B-10	334	378	16	x 1	1/1
B-11	340	186	16	x 1	1/1
B-12	340	24	18	x 4	1/1
B-13	470	120	3	x 1	1/1
B-14	1632	684	3	x 1	1/1

